



GCSE

COMPUTER SCIENCE

Paper 2 Computing concepts

8525/2

Insert

[Turn over]

FIGURE 2

IMAGE A

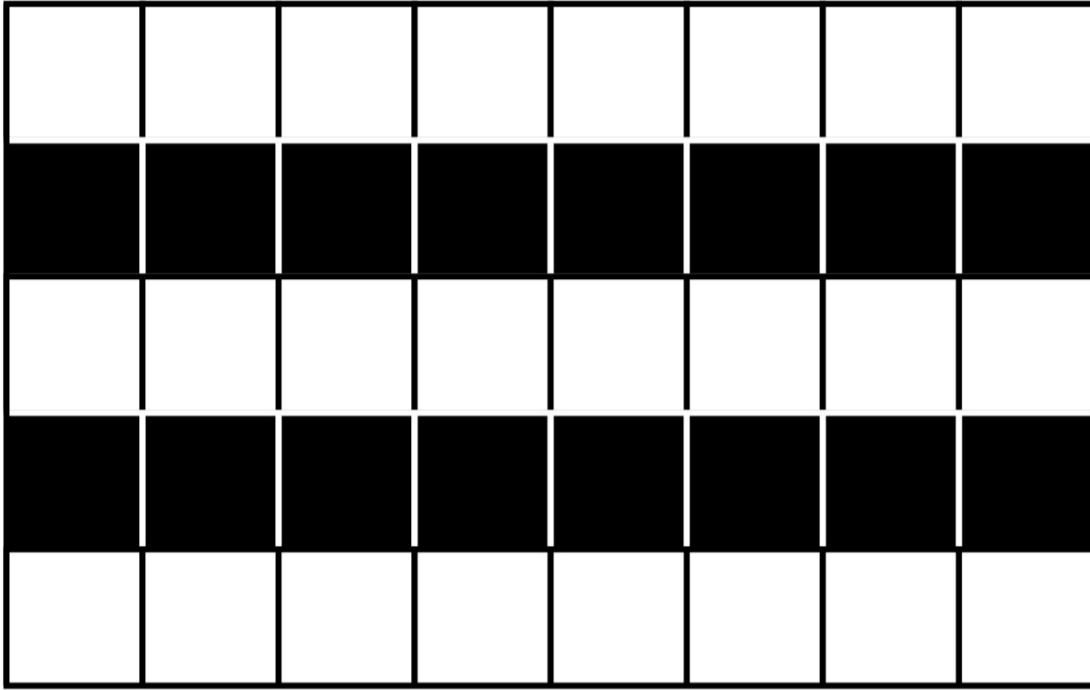

IMAGE B

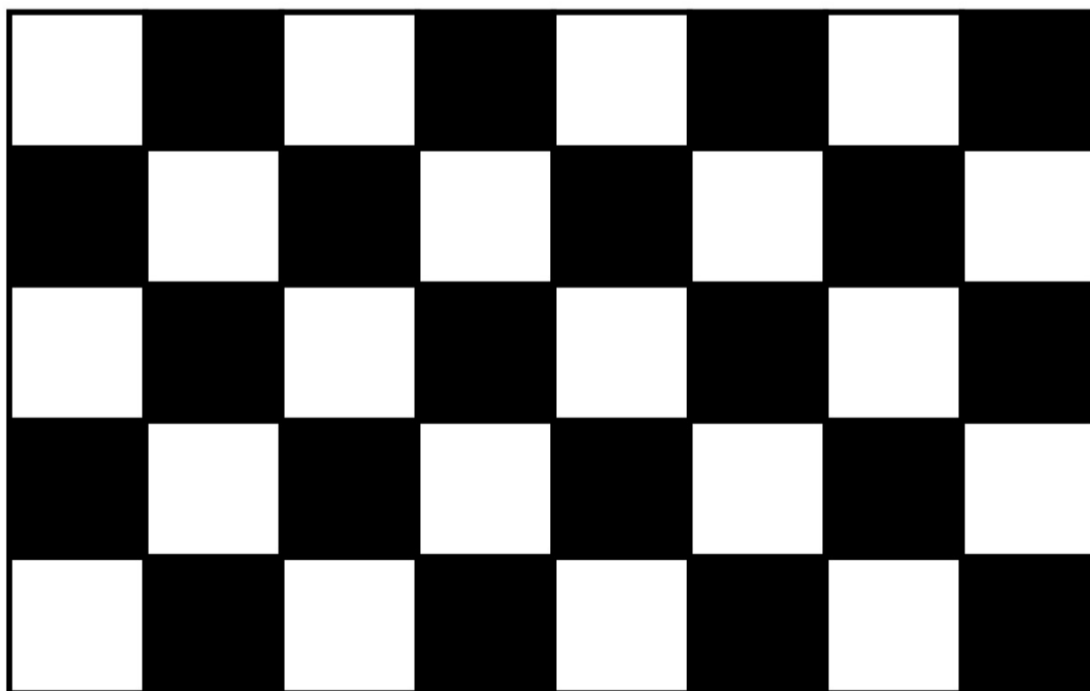

IMAGE C

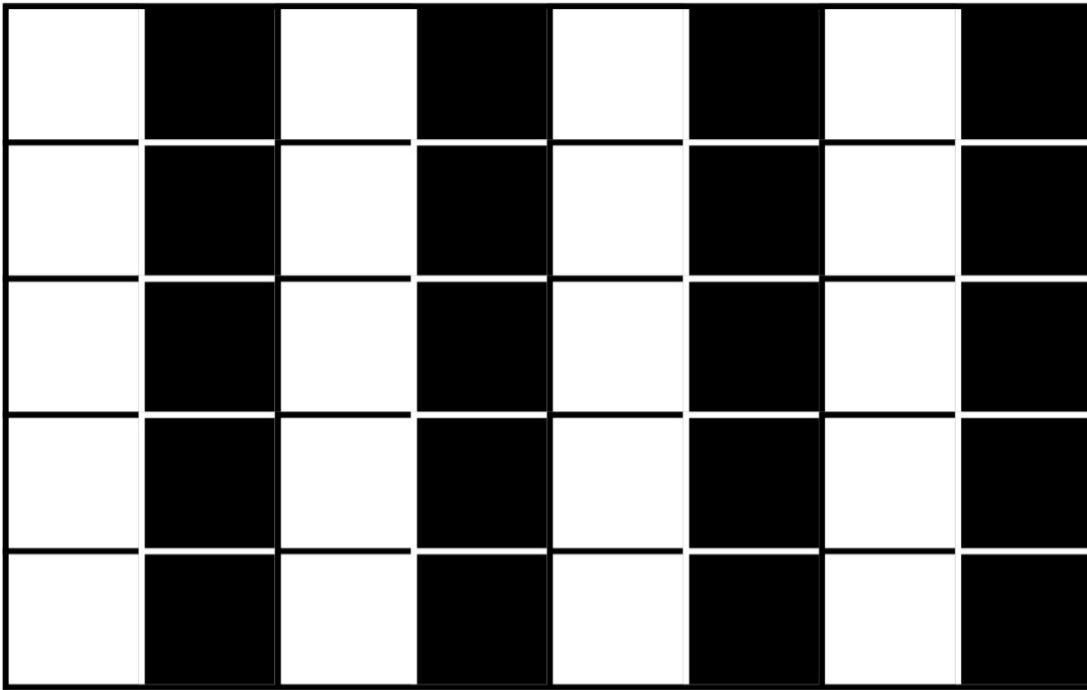
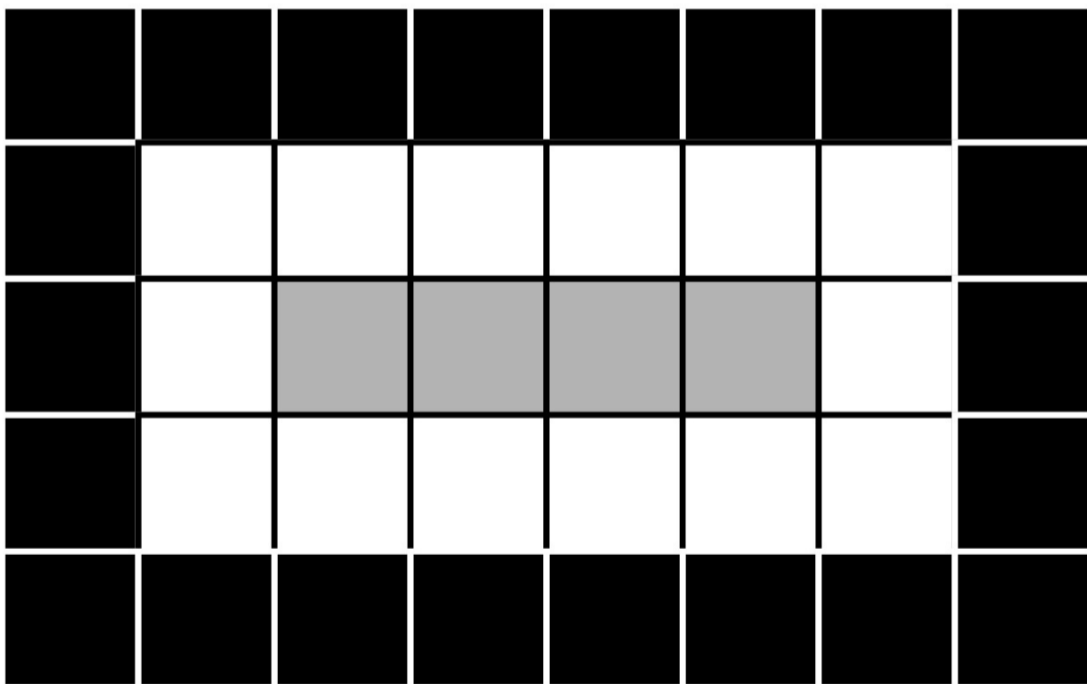
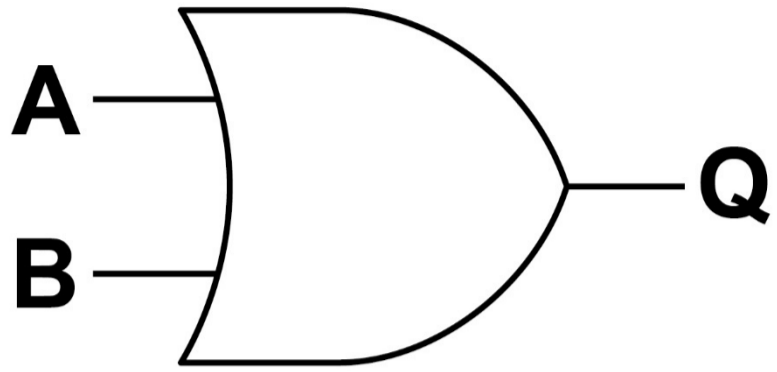

IMAGE D



[Turn over]

FIGURE 4



[Turn over]

FIGURE 5

A	B	C	X	Y	Z
0	0	0	0	0	1
0	0	1	0	1	0
0	1	0	0	0	1
0	1	1	0	1	0
1	0	0	0	0	1
1	0	1	0	1	0
1	1	0	1	1	0
1	1	1	1	0	1

FIGURE 6**[Turn over]**

FIGURE 7



BLANK PAGE

[Turn over]

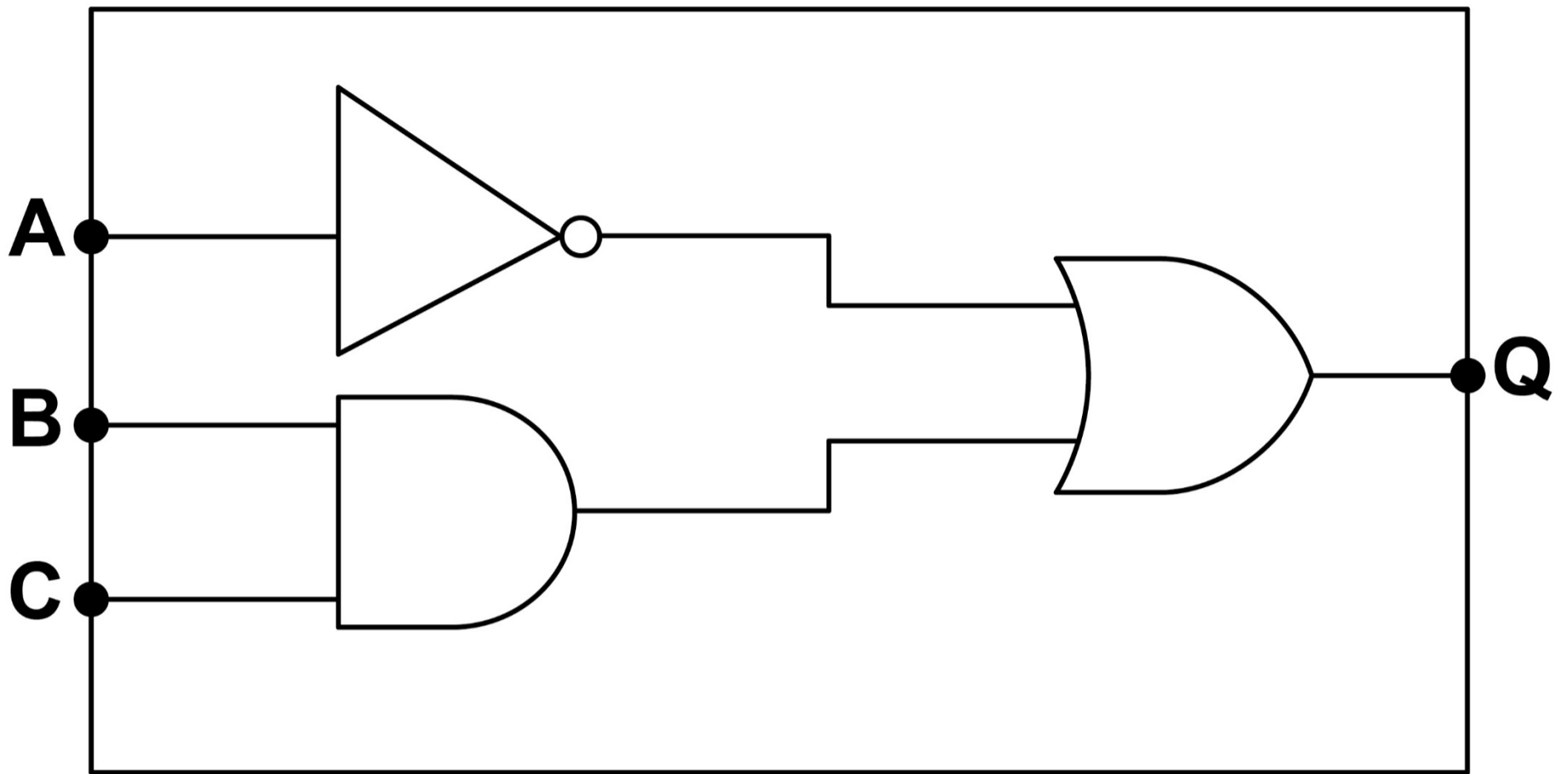
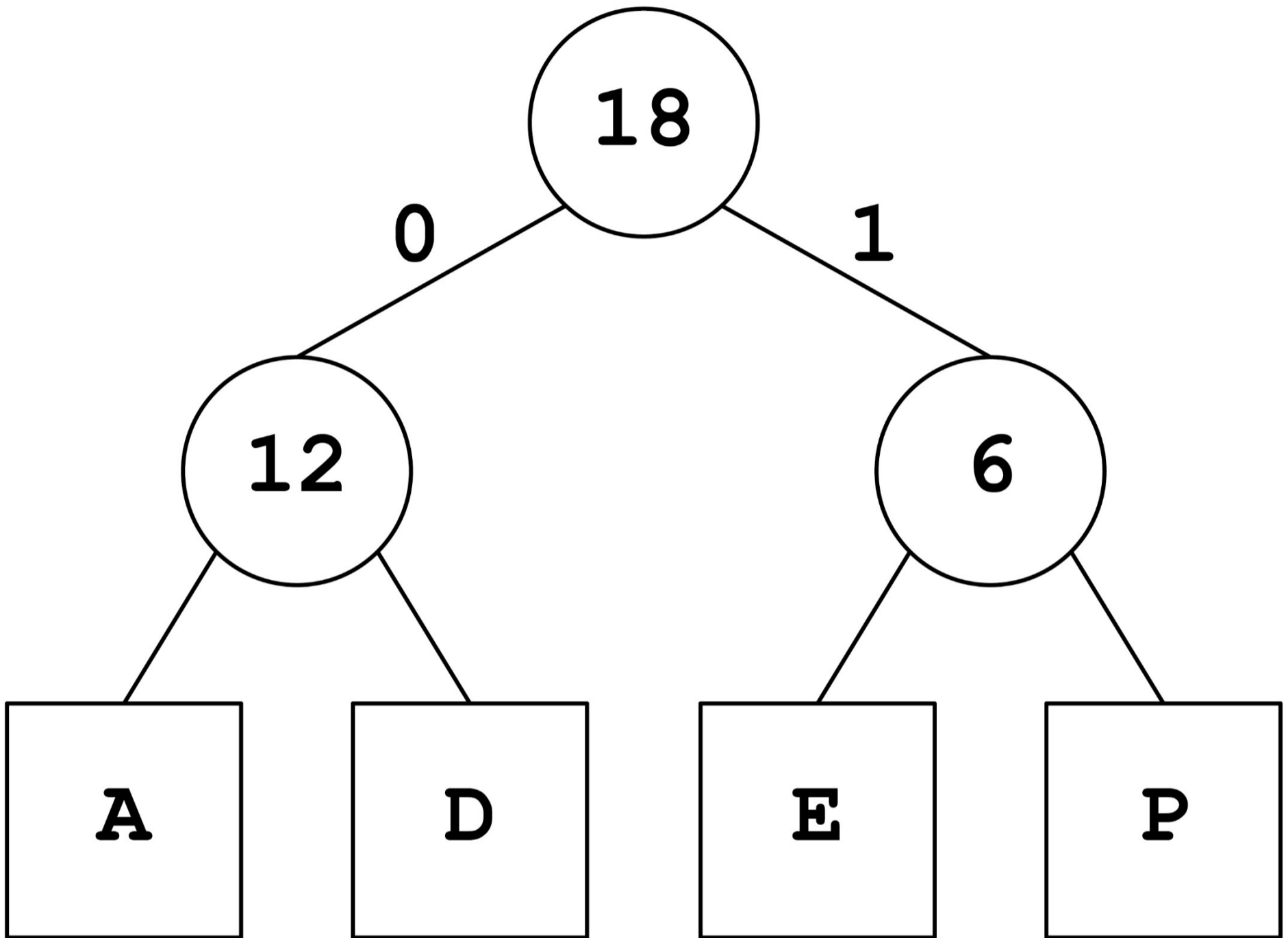
FIGURE 8**FILM**

FilmID	Title	Year
100	Forrest Gump	1994
101	Toy Story 3	2019
102	Back to the Future	1985

PERFORMANCE

PerformanceID	FilmID	ActorID
52	100	8
53	101	8
54	102	9

ACTOR

ActorID	Firstname	Lastname
8	Tom	Hanks
9	Lea	Thompson

END OF SOURCE MATERIAL

BLANK PAGE

Copyright information

For confidentiality purposes, all acknowledgements of third-party copyright material are published in a separate booklet. This booklet is published after each live examination series and is available for free download from www.aqa.org.uk

Permission to reproduce all copyright material has been applied for. In some cases, efforts to contact copyright-holders may have been unsuccessful and AQA will be happy to rectify any omissions of acknowledgements. If you have any queries please contact the Copyright Team.

Copyright © 2024 AQA and its licensors. All rights reserved.

WP/M/SB/Jun24/8525/2/G4004/V2

